

SPOCAL LL - TECHNICAL DETAILS

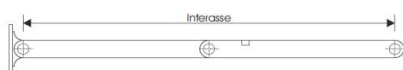

Arms length: 530/380 mm



SPOCAL Guide

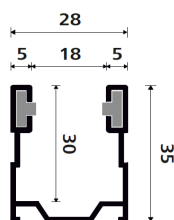

Easy line



SPOCAL LATERAL LEVER FEATURES

The Lateral Lever SPOCAL projection frames, packed in the desired sizes, are composed of:

- **Aluminum guide (measures 28x35 mm)** with anti-noise rubber seals (brush seals on request), split on the top for easy entry of rolling shutter.
- Holes for installation and set up.
- **Aluminum crossbar (measures 18x32 mm).**
- **Aluminum arms (length: 530 mm).**
- **Nylon hinges and nylon inner stoppers.**
- **Stainless steel screws** for installation.

This is recommended for opening widths up to a maximum of 1400 mm.

Suitable for rolling shutters from 8 mm to 15 mm of slat thickness.

OPTIONALS

- **Easy line:** Modification to the hinges to allow the rolling shutter movement even when the projection frame is opened outwards.
- **Aluminum hinges.** Available in these colours: Silver anodized, Bronze anodized, Black anodized, White RAL 9010, Ivory RAL 1013, Green RAL 6005, Brown RAL 8017. Other colours available upon request.
- **Arms of 380 mm in length.**
- **Painted arms.** Available in these colours: White RAL 9010, Ivory RAL 1013, Green RAL 6005, Brown RAL 8017. Other colours available upon request.

HOW TO ORDER:

- Provide window opening measurements: **Opening Width (L) X Opening Height (H).** If Type Rome, specify also additional measures of the right and the left side with respect to the opening width.
- **Specify the slat thickness.**
- **Specify projection frame colours and any optionals.**

SPOCAL LL COLOUR MATCHING

| Guides and Crossbars | Arms STANDARD | Nylon Hinges and Inner Stoppers |
|--|-----------------|---------------------------------|
| Silver Anodized | Silver Anodized | Grey |
| Bronze Anodized | Bronze Anodized | Bronze |
| Black RAL 9005 | Black Anodized | Black |
| White RAL 9010 - Ivory RAL 1013 | Silver Anodized | White - Ivory |
| Green RAL 6005 - Brown RAL 8017 | Black Anodized | Green - Brown |
| White Michelangelo | Silver Anodized | White |
| Grey Mich. - Green Mich. - Red Mich. - Brown Mich. - Brown RAL 8014 - Green Olive RAL 6011 - Green Signal RAL 6024 - Moss-Green - Moss-Brown | Black Anodized | Black |
| Grey RAL 7001 | Silver Anodized | Grey |
| RAL on request | Anodized | Choice between the above colors |

SPOCAL LL - TECHNICAL DETAILS

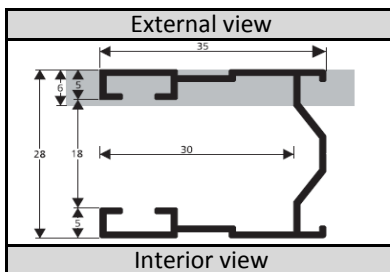
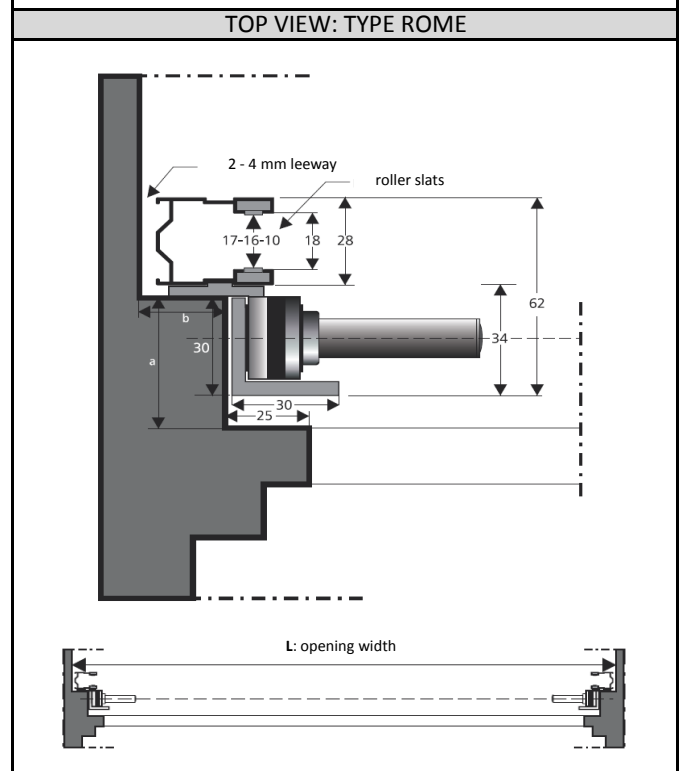
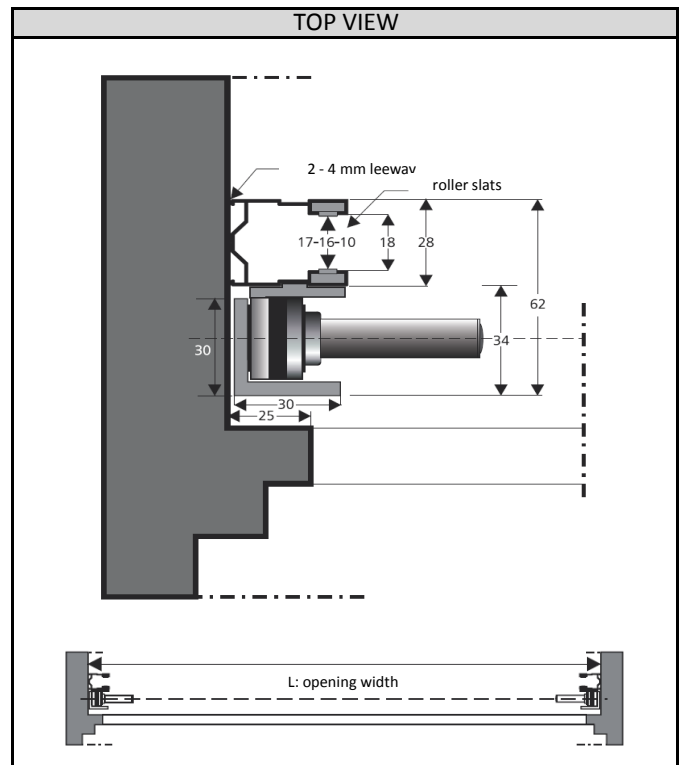
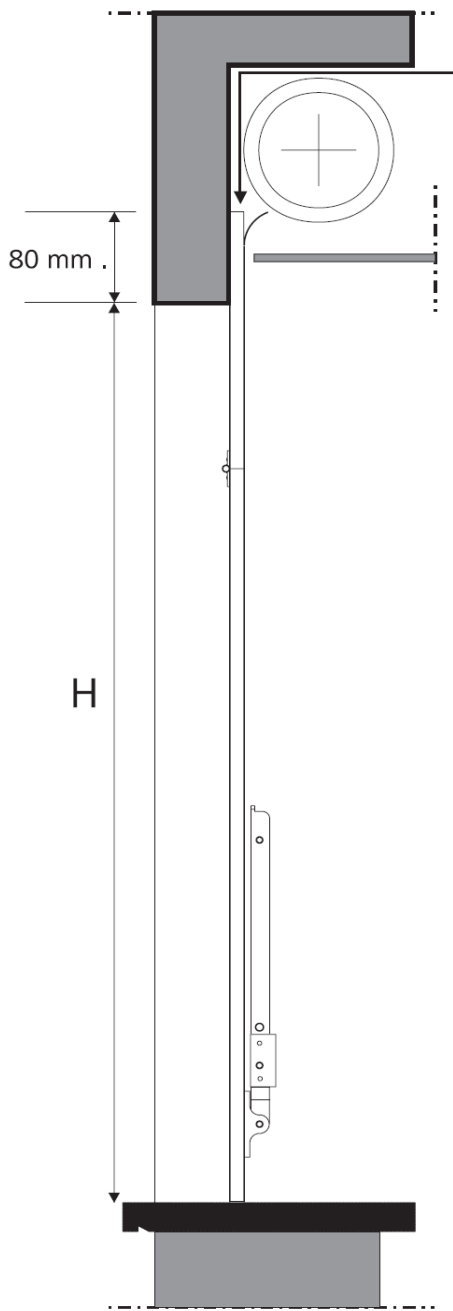

Dis. B
Spocal Guide

Suggestions:

The Spocal guide needs a space of 30 mm. Removing 6 mm from the external part of the guide for the stretch exceeding the window opening (in the picture 80 mm), there is enough for a space of 24 mm (see Dis. B).

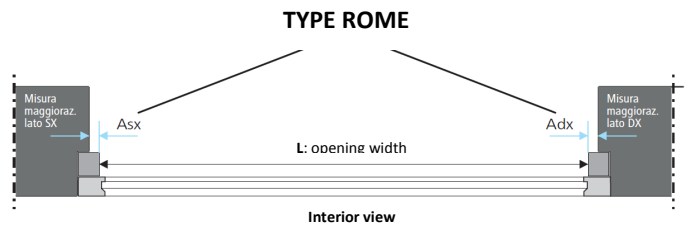
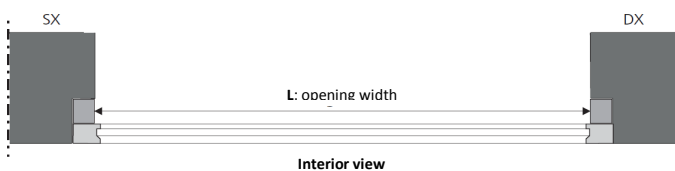

SPOCAL LC - TECHNICAL DETAILS



Arms length: 530/380 mm

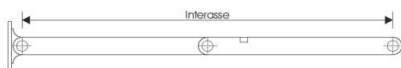

SPOCAL Guide

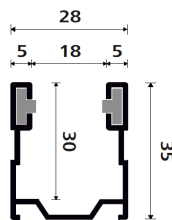

Easy line



SPOCAL CENTRAL LEVER FEATURES

Central Lever SPOCAL projection frames, packed in the desired sizes, are composed of:

- **Aluminum guide (measures 28x35 mm)** with anti-noise rubber seals (brush seals on request), split on the top for easy entry of rolling shutter.
- Holes for installation and set up.
- **Aluminum crossbar (measures 18x32 mm).**
- **Aluminum arms (length: 530 mm).**
- **Aluminum rod and handle** in the same colour as arms.
- **Nylon hinges and nylon inner stoppers.**
- **Nylon rest arms LC.**
- **Stainless steel screws** for installation.

This is recommended for windows over 1400 mm in width and up to a maximum of 3000 mm in width.

A double handle and a reinforcement inside the crossbar are installed on the frame for rolling shutters from 2300 mm to 3000 mm wide, unless otherwise specified.

OPTIONALS

- **Easy line:** Modification to the hinges to allow the rolling shutter movement even when the projection frame is opened outwards.
- **Aluminum hinges.** Available in these colours: Silver anodized, Bronze anodized, Black anodized, White RAL 9010, Ivory RAL 1013, Green RAL 6005, Brown RAL 8017. Other colours available upon request.
- **Arms of 380 mm in length.**
- **Painted arms, rod and handle.** Available in these colours: White RAL 9010, Ivory RAL 1013, Green RAL 6005, Brown RAL 8017. Other colours available upon request.

HOW TO ORDER:

- Provide window opening measurements: **Opening Width (L) X Opening Height (H).** If Type Rome, specify also additional measures of the right and the left side with respect to the opening width.
- **Specify the slat thickness.**
- **Specify projection frame colours and any optionals.**

SPOCAL LC COLOUR MATCHING

| Guides and Crossbars | Arms, rod and handle STANDARD | Nylon Hinges and Inner stoppers |
|--|-------------------------------|---------------------------------|
| Silver Anodized | Silver Anodized | Grey |
| Bronze Anodized | Bronze Anodized | Bronze |
| Black RAL 9005 | Black Anodized | Black |
| White RAL 9010 - Ivory RAL 1013 | Silver Anodized | White - Ivory |
| Green RAL 6005 - Brown RAL 8017 | Black Anodized | Green - Brown |
| White Michelangelo | Silver Anodized | White |
| Grey Mich. - Green Mich. - Red Mich. - Brown Mich. - Brown RAL 8014 - Green Olive RAL 6011 - Green Signal RAL 6024 - Moss-Green - Moss-Brown | Black Anodized | Black |
| Grey RAL 7001 | Silver Anodized | Grey |
| RAL on request | Anodized | Choice between the above colors |

SPOCAL LC - TECHNICAL DETAILS

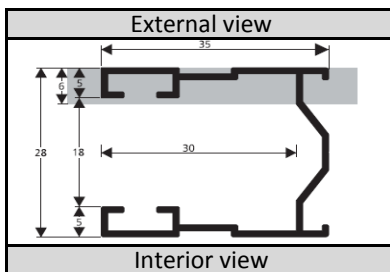
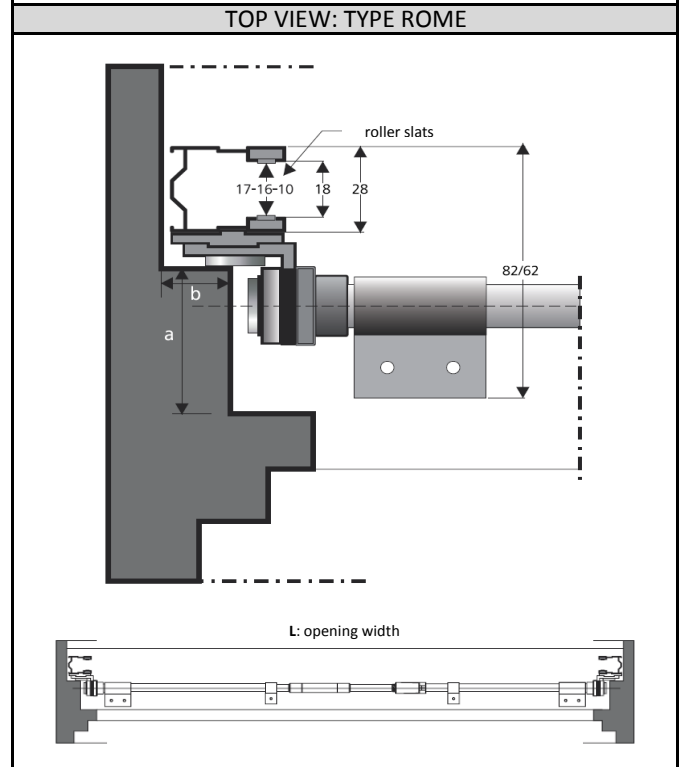
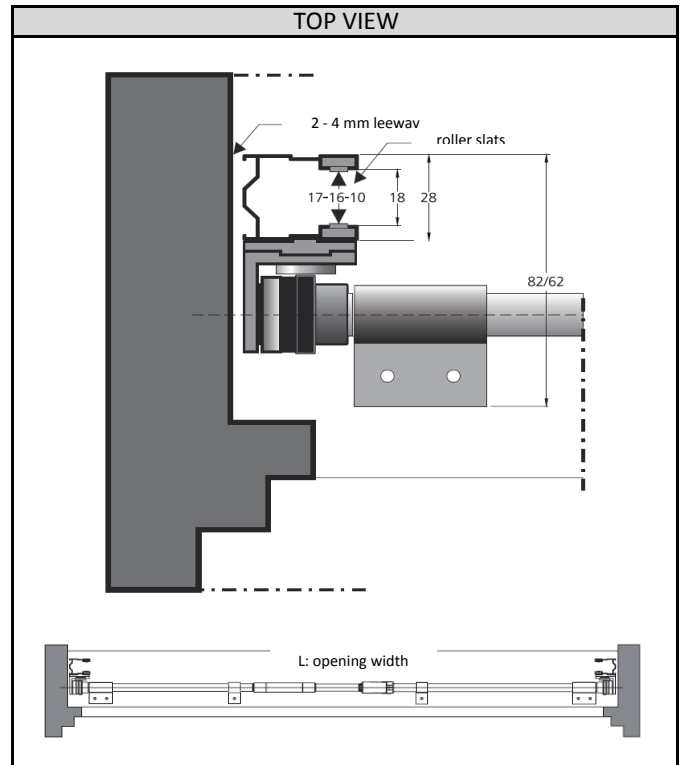
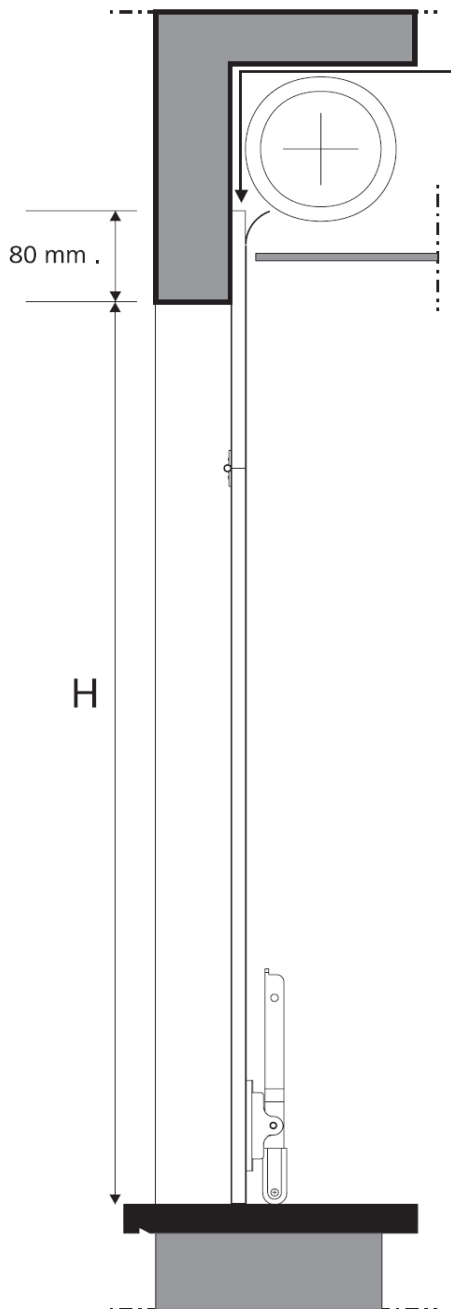

Dis. B
Spocal Guide

Suggestions:
The Spocal guide needs a space of 30 mm. Removing 6 mm from the external part of the guide for the stretch exceeding the window opening (in the picture 80 mm), there is enough for a space of 24 mm (see Dis. B).

