

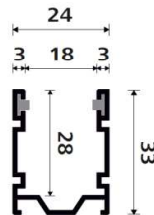

Arms length: 530/380 mm

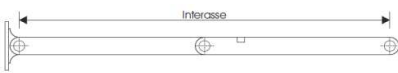

SPOCAL  
LIGHT  
Guide

Easy line



Security crossbar



Rod installed on the crossbar



## STARK LATERAL LEVER FEATURES

Lateral Lever STARK projection frames, packed in the desired sizes, are composed of:

- **Aluminum guide (measures 24x33 mm)** with anti-noise rubber seals (brush seals on request), split on the top for easy entry of rolling shutter.
- Holes for installation and set up.
- **Aluminum crossbar (measures 18x30 mm).**
- **Aluminum arms (length: 530 mm).**
- **Aluminum rod installed on the crossbar.**
- **Nylon hinges and nylon inner stoppers.**
- **Stainless steel screws** for installation.

This is recommended for opening widths up to a maximum of 1800 mm.

Suitable for rolling shutters from 8 mm to 15 mm of slat thickness.

## OPTIONALS

- **Easy line:** Modification to the hinges to allow the rolling shutter movement even when the projection frame is opened outwards.
- **Aluminum hinges.** Available in these colours: Silver anodized, Bronze anodized, Black anodized, White RAL 9010, Ivory RAL 1013, Green RAL 6005, Brown RAL 8017. Other colours available upon request.
- **Arms of 380 mm in length.**
- **Security crossbar with safety bolts\***

## HOW TO ORDER:

- Provide window opening measurements:  
**Opening Width (L) X Opening Height (H).**  
If Type Rome, specify also additional measures of the right and the left side with respect to the opening width.
- **Specify the slat thickness.**
- **Specify projection frame colours and any optionals.**

\*with the security crossbar, the inner stoppers are black.

## STARK LL COLOUR MATCHING

Guides and Crossbars	Arms	Nylon Hinges and Inner stoppers
Silver Anodized	Silver Anodized	Grey
Bronze Anodized	Bronze Anodized	Bronze
Black RAL 9005	Black Anodized	Black
White RAL 9010 - Ivory RAL 1013	Silver Anodized	White - Ivory
Green RAL 6005 - Brown RAL 8017	Black Anodized	Green - Brown
RAL on request	Anodized	Choice between the above colors

# STARK LL - TECHNICAL DETAILS

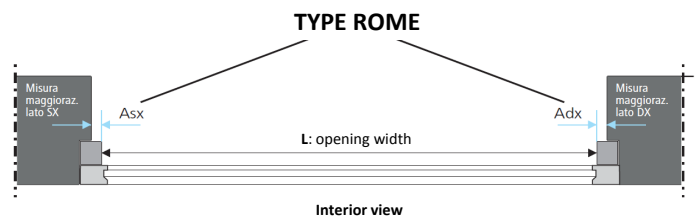
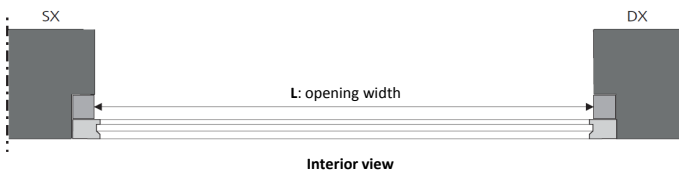
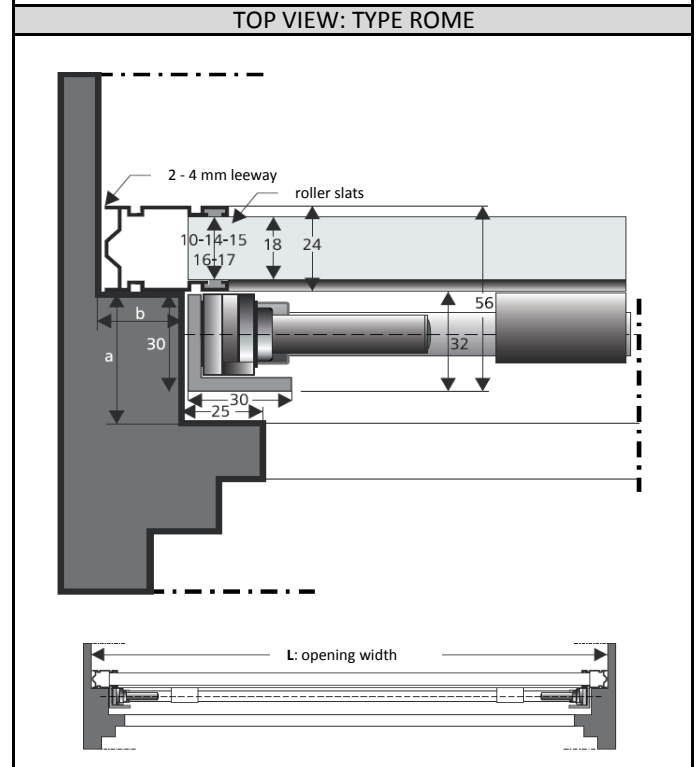
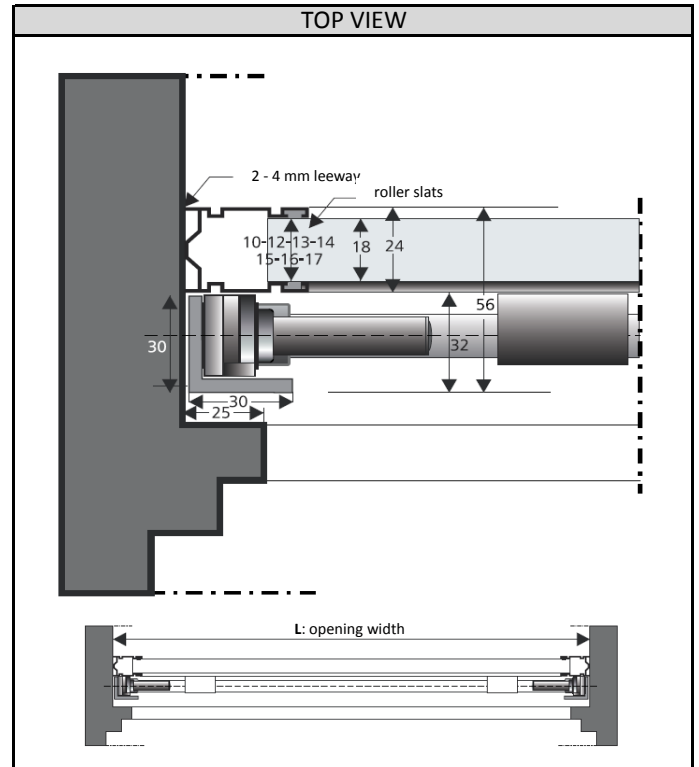
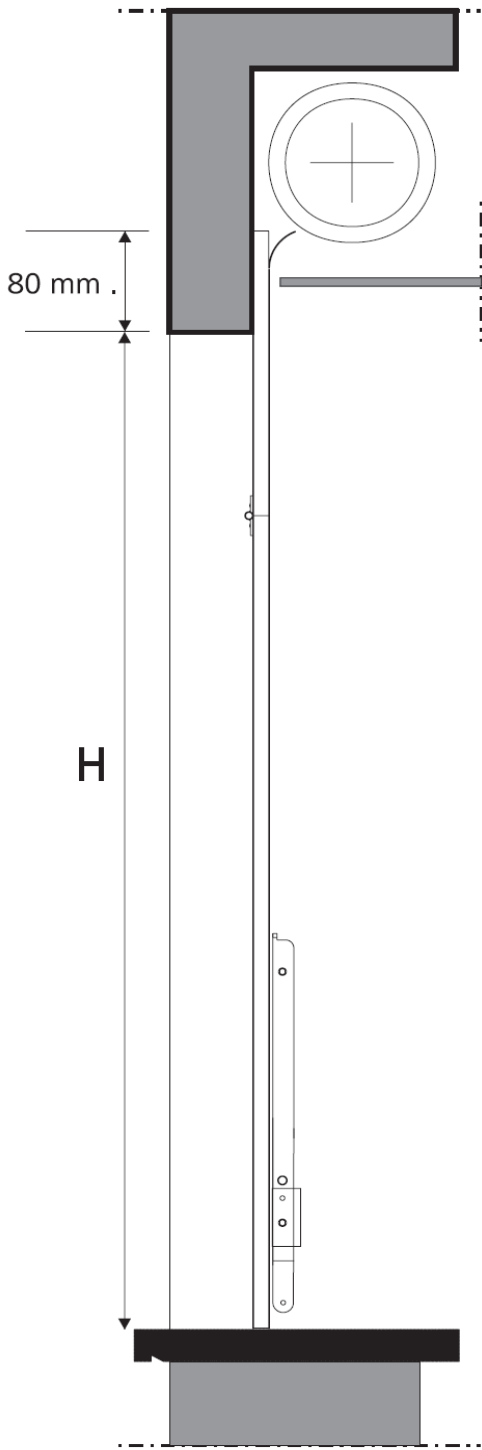

# STARK LC - TECHNICAL DETAILS



Arms length: 530/380 mm

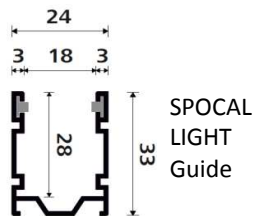
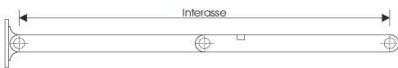

SPOCAL  
LIGHT  
Guide

STARK crossbar for Central Lever



Easy line



## STARK CENTRAL LEVER FEATURES

Central Lever STARK projection frames, packed in the desired sizes, are composed of:

- **Aluminum guide (measures 24x33 mm)** with anti-noise rubber seals (brush seals on request), split on the top for easy entry of rolling shutter.
- Holes for installation and set up.
- **Aluminum crossbar (measures 18x60 mm) assembled with mechanism lock and safety bolts inserted.**
- **Aluminum rod and handle** in the same colour as arms.
- **Aluminum arms (length: 530 mm).**
- **Nylon hinges and nylon inner stoppers.**
- **Nylon rest arms LC.**
- **Stainless steel screws** for installation.

**This is recommended for windows over 1800 mm in width and up to a maximum of 2500 mm in width.**

**Suitable for rolling shutters from 8 mm to 15 mm of slat thickness.**

## OPTIONALS

- **Easy line:** Modification to the hinges to allow the rolling shutter movement even when the projection frame is opened outwards.
- **Aluminum hinges.** Available in these colours: Silver anodized, Bronze anodized, Black anodized, White RAL 9010, Ivory RAL 1013, Green RAL 6005, Brown RAL 8017. Other colours available upon request.
- **Arms of 380 mm in length.**

## HOW TO ORDER:

- Provide window opening measurements:  
**Opening Width (L) X Opening Height (H).**  
If Type Rome, specify also additional measures of the right and the left side with respect to the opening width.
- **Specify the slat thickness.**
- **Specify projection frame colours and any optionals.**

## STARK LC COLOUR MATCHING

Guides and Crossbars	Arms, Rod and Handle	Nylon Hinges	Nylon Inner stoppers
Silver Anodized	Silver Anodized	Grey	Black
Bronze Anodized	Bronze Anodized	Bronze	Black
Black RAL 9005	Black Anodized	Black	Black
White RAL 9010 - Ivory RAL 1013	Silver Anodized	White - Ivory	Black
Green RAL 6005 - Brown RAL 8017	Black Anodized	Green - Brown	Black
<i>RAL on request</i>	Anodized	Choice	Black

# STARK LC - TECHNICAL DETAILS

