

Steel arms

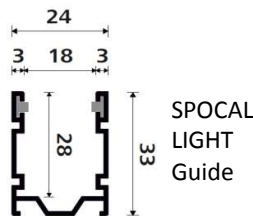

SPOCAL LIGHT Guide



Easy line

ALUEC LATERAL LEVER FEATURES

Lateral Lever ALUEC projection frames, packed in the desired sizes, are composed of:

- **Aluminum guide (measures 24x33 mm)** with anti-noise rubber seals (brush seals on request), split on the top for easy entry of rolling shutter.
- Holes for installation and set up.
- **Aluminum crossbar (measures 18x30 mm).**
- **Steel arms (length: 540 mm)** with locking snap knobs.
- **Nylon hinges and nylon inner stoppers.**
- **Stainless steel screws** for installation.

This is recommended for opening widths up to a maximum of 1400 mm.

Suitable for rolling shutters from 8 mm to 15 mm of slat thickness.

OPTIONALS

- **Easy line:** Modification to the hinges to allow the rolling shutter movement even when the projection frame is opened outwards.
- **Aluminum hinges.** Available in these colours: Silver anodized, Bronze anodized, Black anodized, White RAL 9010, Ivory RAL 1013, Green RAL 6005, Brown RAL 8017. Other colours available upon request.

HOW TO ORDER:

- Provide window opening measurements: **Opening Width (L) X Opening Height (H).** If Type Rome, specify also additional measures of the right and the left side with respect to the opening width.
- **Specify the slat thickness.**
- **Specify projection frame colours and any optionals.**

ALUEC LL COLOUR MATCHING

Guides and Crossbars	Arms (length: 540 mm)	Nylon Hinges and Inner Stoppers
Silver Anodized	Galvanized steel	Grey
Bronze Anodized	Galvanized steel	Bronze
Black RAL 9005	Galvanized steel	Black
White RAL 9010 - Ivory RAL 1013	Galvanized steel	White - Ivory
Green RAL 6005 - Brown RAL 8017	Galvanized steel	Green - Brown
RAL on request	Galvanized steel	Choice between the above colors

ALUEC LL - TECHNICAL DETAILS

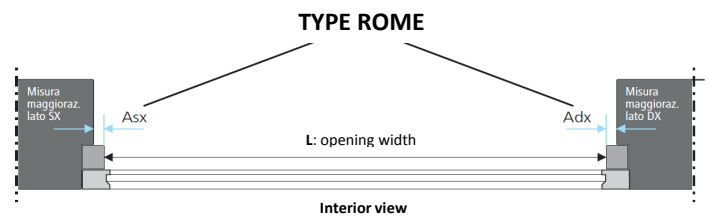
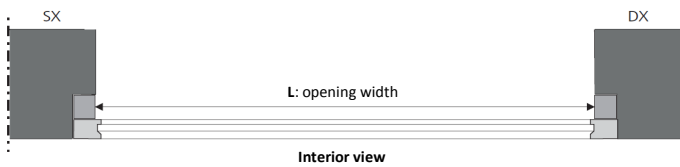
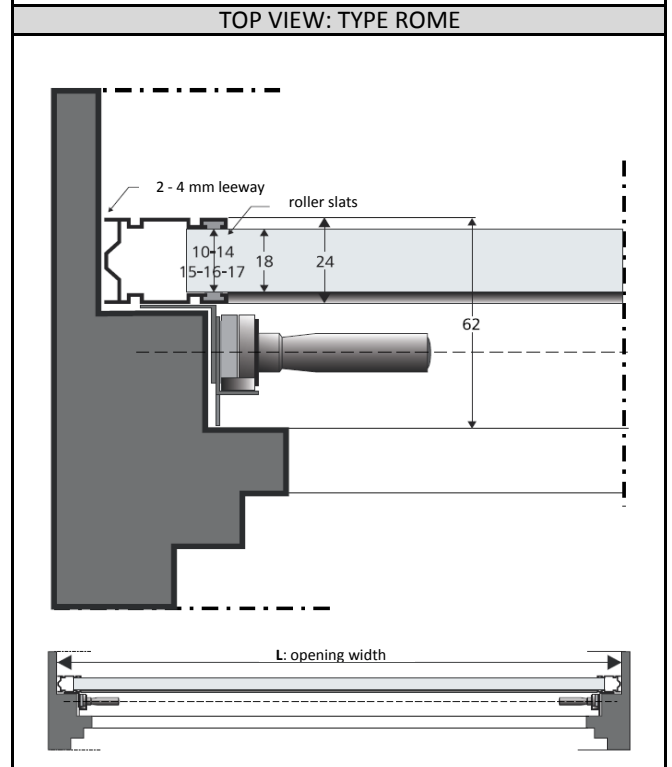
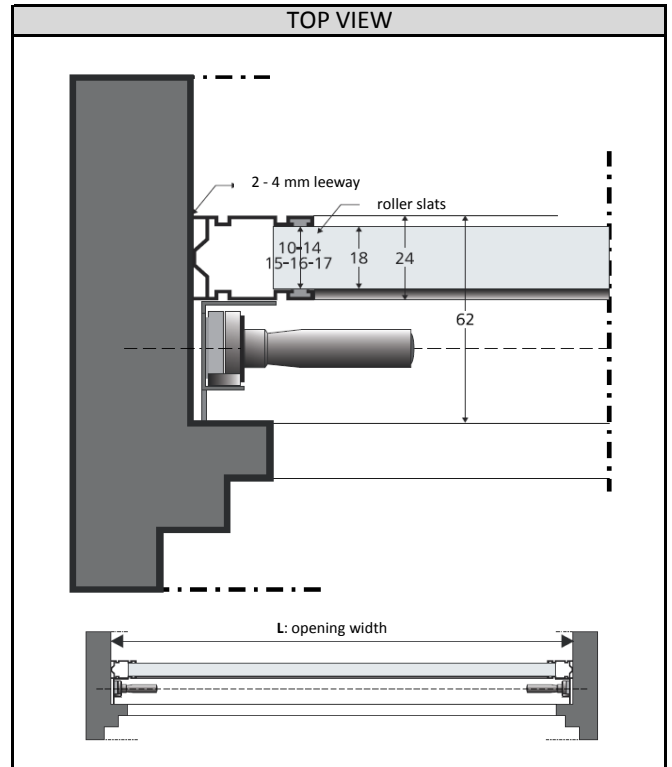
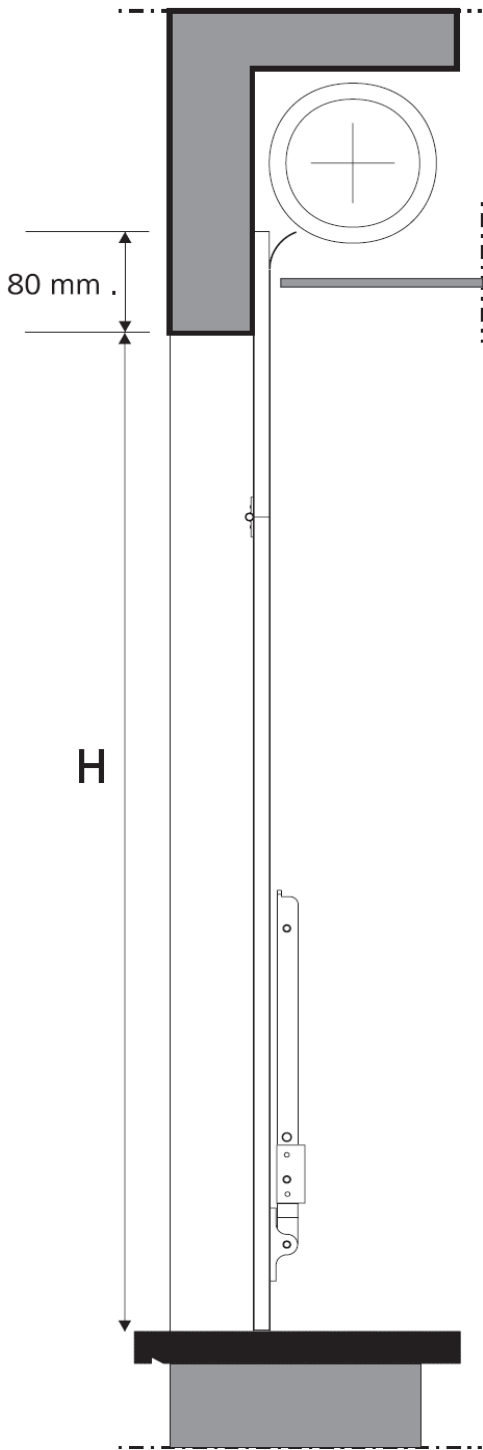

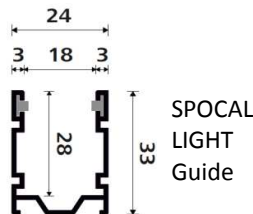
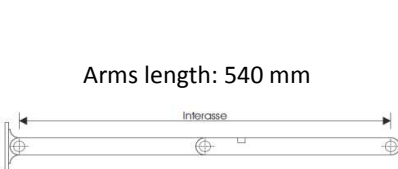

Rod Central Lever



Easy line

ALUEC LATERAL LEVER FEATURES

Lateral Lever ALUEC projection frames, packed in the desired sizes, are composed of:

- **Aluminum guide (measures 24x33 mm)** with anti-noise rubber seals (brush seals on request), split on the top for easy entry of rolling shutter.
- Holes for installation and set up.
- **Aluminum crossbar (measures 18x30 mm).**
- **Steel arms (length 540 mm)** without welding but connected to the rod by a nylon axle box to avoid damaging the galvanization of various components.
- **Anodized aluminum rod** with galvanized steel arms, hand lever and accessories.
- **Nylon hinges and nylon inner stoppers.**
- **Nylon rest arms LC.**
- **Stainless steel screws** for installation.

This is recommended for windows over 1400 mm in width and up to a maximum of 2500 mm in width.

A double handle and a reinforcement inside the crossbar are installed on the frame for rolling shutters from 2300 mm to 3000 mm wide, unless otherwise specified.

Suitable for rolling shutters from 8 mm to 15 mm of slat thickness.

OPTIONALS

- **Easy line:** Modification to the hinges to allow the rolling shutter movement even when the projection frame is opened outwards.
- **Aluminum hinges.** Available in these colours: Silver anodized, Bronze anodized, Black anodized, White RAL 9010, Ivory RAL 1013, Green RAL 6005, Brown RAL 8017. Other colours available upon request.

HOW TO ORDER:

- Provide the opening window measurements: **Opening Width (L) X Opening Height (H).** If Type Rome, specify also additional measures of the right and the left side with respect to the opening width.
- **Specify the slat thickness.**
- **Specify projection frame colours and any optionals.**

ALUEC LL COLOUR MATCHING

Guides and Crossbars	Arms, handle, eyelets	Rod	Nylon Hinges and Inner Stoppers
Silver Anodized	Galvanized steel	Silver Anod.	Grey
Bronze Anodized	Galvanized steel	Silver Anod.	Bronze
Black RAL 9005	Galvanized steel	Silver Anod.	Black
White RAL 9010 - Ivory RAL 1013	Galvanized steel	Silver Anod.	White - Ivory
Green RAL 6005 - Brown RAL 8017	Galvanized steel	Silver Anod.	Green - Brown
<i>RAL on request</i>	Galvanized steel	Silver Anod.	<i>Choice between the above colors</i>

ALUEC LC - TECHNICAL DETAILS

